

712C RTD Calibrator

快速参考指南 / Quick Reference Guide

警告 / Warning

为了防止可能发生的电击、火灾或人身伤害，使用本产品前请阅读《712C 安全说明书》。

To prevent possible electrical shock, fire, or personal injury, read the "712C Safety Sheet" before you use this Product.

请至 www.fluke.com 注册您的产品、下载手册，并获取更多信息。

Go to www.fluke.com to register your product, download manuals, and find more information.

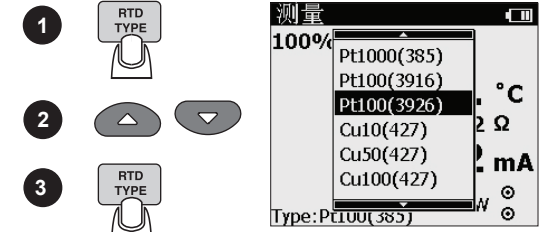
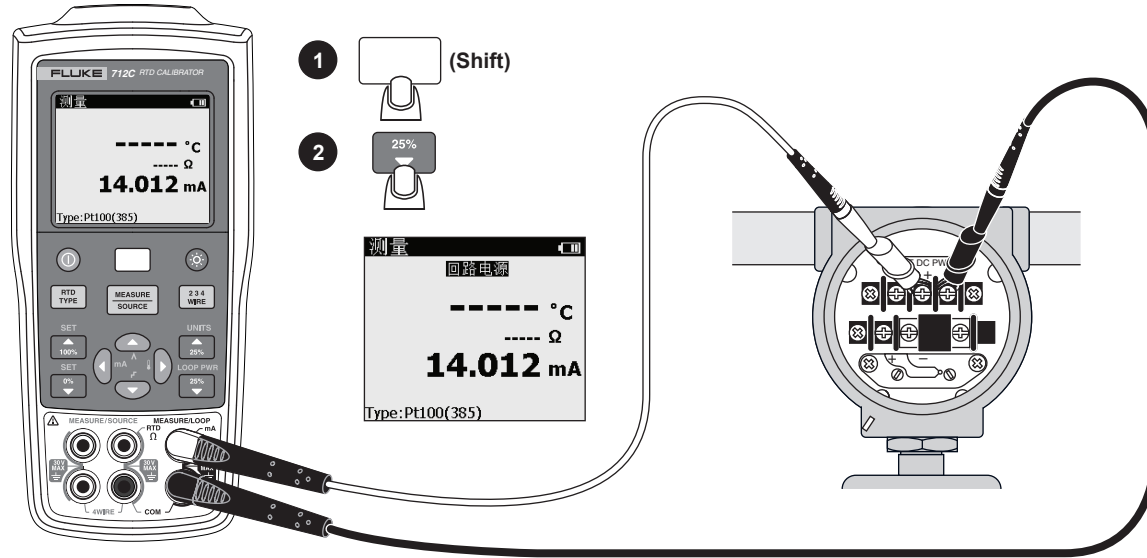

设置 / Settings

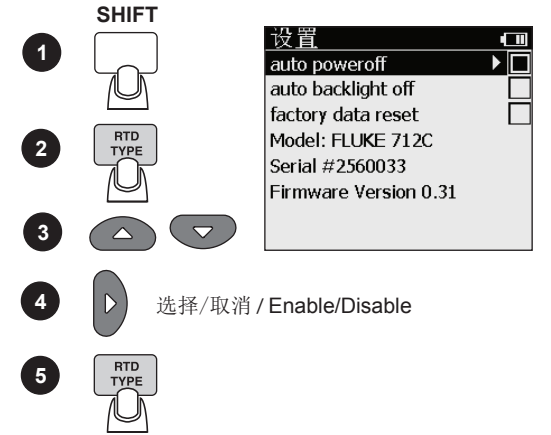

磁性挂带 / Magnetic Hanger

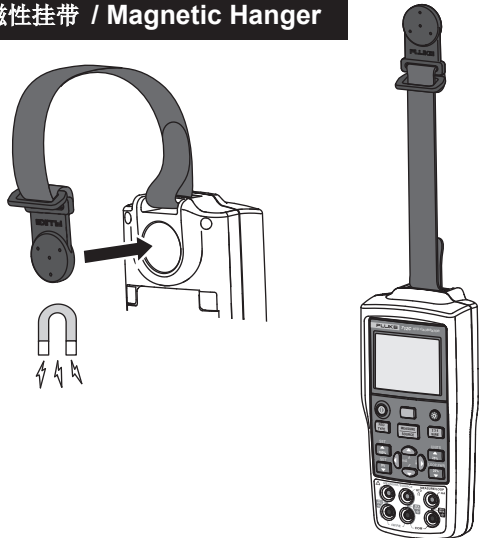

RTD 测量 / Measure

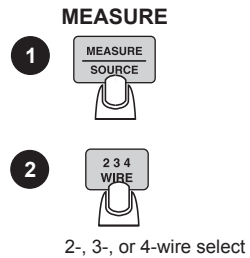

RTD 温度测量 / Temperature with RTD

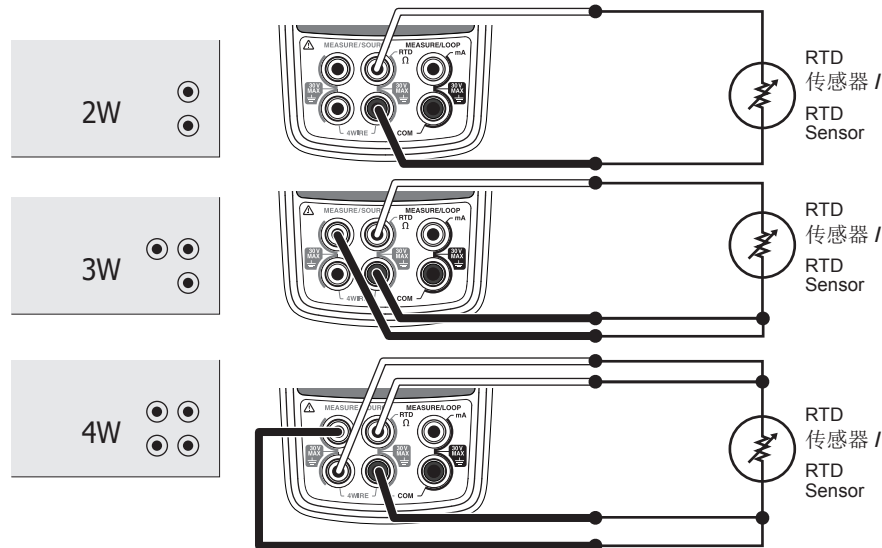

单位转换 / Units

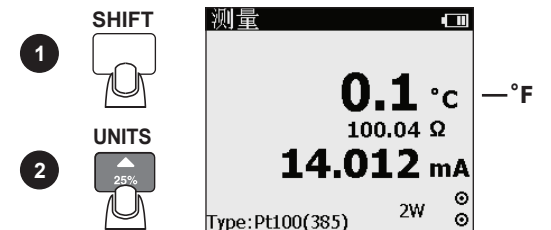

输出 / Source

RTD 输出 / Simulate RTD

设置 RTD 温度 / Temperature RTD

输出 / Source

输出输出 2W/3W/4W RTD / Simulate/Source 2W/3W/4W RTD

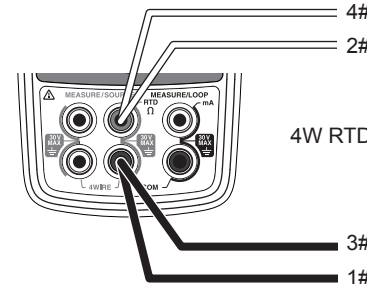
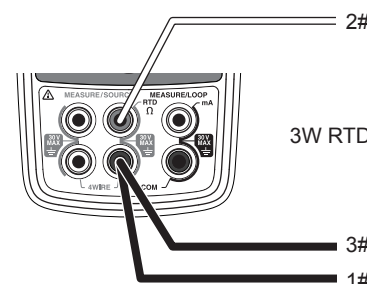
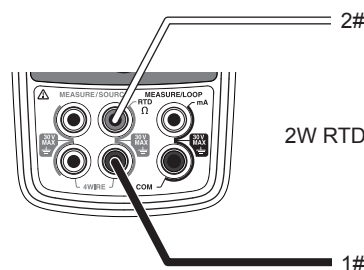
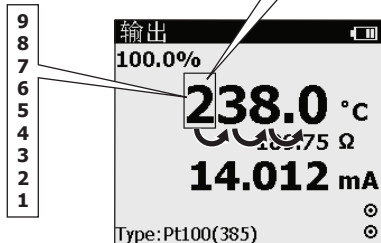
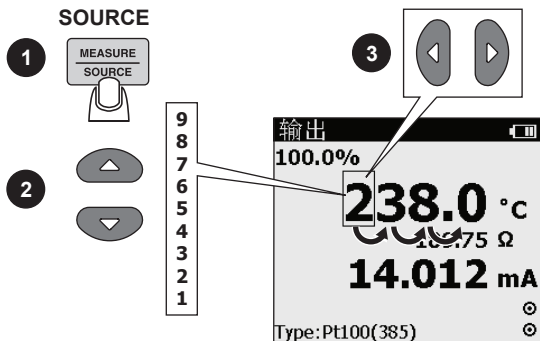
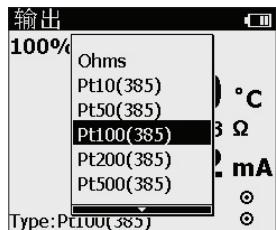
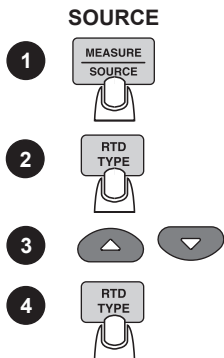

对比度 / Contrast

0%

比例输出 / Linearity or Span Test

毫安通道温度换算 / Scale mA Channel to Temperature

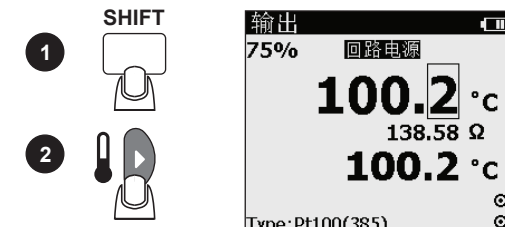
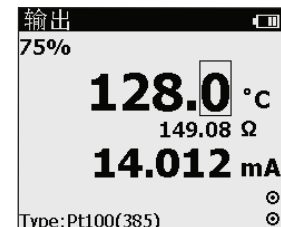
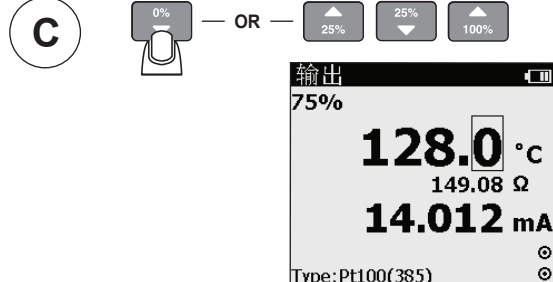
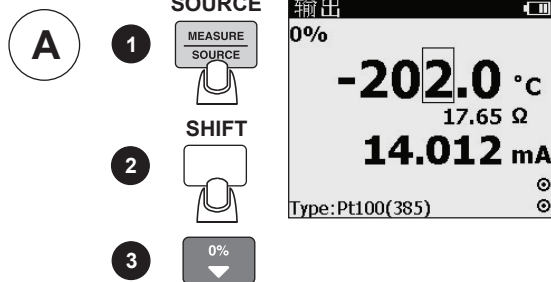
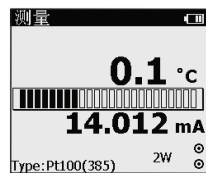
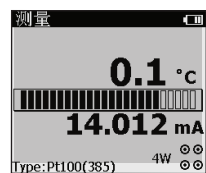
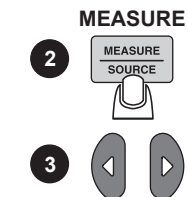

100%

斜坡或步进 / Ramp or Step

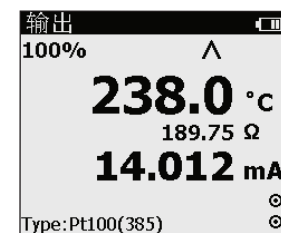
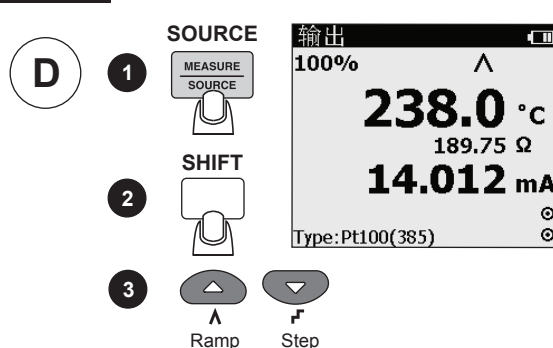
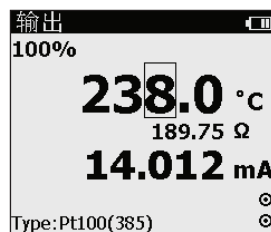
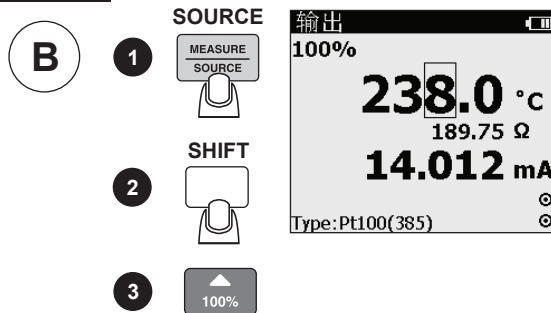
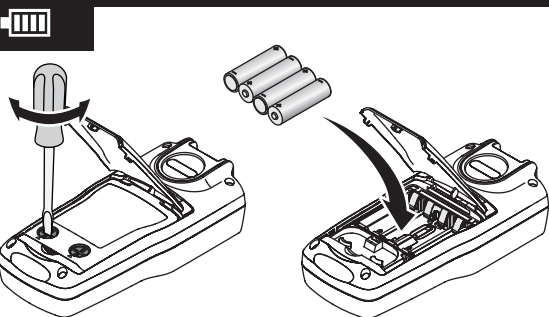

注意：
4 mA 转换温度 = 0 % 预设温度
20 mA 转换温度 = 100 % 预设温度

Note:
Temperature at 4 mA =
Span check 0 %
Temperature at 20 mA =
Span check 100 %